

FLOODPLAIN DEVELOPMENT PERMIT APPLICATION

Elmore County, Idaho

Fee: \$250.00

Date Received: _____ Amount Received: _____ Receipt #: _____ Received By: _____

Building Permit No.: _____

We are unable to accept facsimile copies. This application must be completed in detail in INK and submitted to the office of the Growth and Development Department for Elmore County, Idaho.

SECTION 1: COMPLETED BY APPLICANT

Name of Applicant: _____

Applicant Address: _____

Daytime Phone: _____ Other Phone: _____

E-Mail Address: _____

Location of Proposed Development: _____

Legal Description of Proposed Development: _____

Parcel Number: _____

Description of Proposed Work(s):

- | | | |
|--|---|---|
| <input type="checkbox"/> New Building | <input type="checkbox"/> Addition/Alteration | <input type="checkbox"/> Subdivision of Land |
| <input type="checkbox"/> Residential | <input type="checkbox"/> Mobile Home Placement | <input type="checkbox"/> Fill |
| <input type="checkbox"/> Non-Residential | <input type="checkbox"/> On Single Lot | <input type="checkbox"/> Watercourse Alteration |
| <input type="checkbox"/> Structure (other than Building) | <input type="checkbox"/> Other (describe on Line ↓) | Estimated Cost \$ _____ |

SECTION 2: COMPLETED BY LOCAL ADMINISTRATOR

The proposed development is located in the Floodplain Flood fringe Floodway

The Base Flood Elevation or depth number at the development site: _____

Source Documents: _____ Map Effective Date: _____

Per Elmore County Flood Damage Prevention Ordinance, the as-built MSL elevation of the lowest floor (including basement) shall be elevated/flood proofed at or above the Base Flood Elevation or depth number.

SECTION 3: COMPLETED BY IDAHO LICENSED PROFESSIONAL ENGINEER OR LAND SURVEYOR

Attach the following information where applicable: Plans of the development to be undertaken including any filling and any watercourse or drainage way alteration.

Specifically, the following information is required: (1) Mean Sea Level (MSL) elevation of the lowest floor (including basement) of all proposed structures; (2) MSL elevation to which any proposed structure will be flood proofed; (3) Certification by a registered professional engineer or architect that the flood proofing method meets the community flood proofing criteria; (4) a description of the extent to which any watercourse will be altered or relocated; and (5) base (110-year) flood elevation data for a development or subdivision.

- Temporary alteration Permanent alteration
 Certification attached that water carrying capacity of watercourse will not be reduced.
 Certification attached that water surface elevation of watercourse is not increased more than one (1) foot.

Elevation Certificate attached: yes no

Idaho Department of Water Resources (IDWR),
U.S. Army Corps of Engineers (USACE),
Idaho Department of Lands (IDL)

Joint Application for Stream Channel Alteration Permit applied for: yes no

The certified as-built MSL elevation of the lowest floor of the structure is _____ feet.

The certified as-built MSL flood proofed elevation of the structure is _____ feet.

Certificates of a registered professional engineer or land surveyor licensed in the State of Idaho documenting these elevation(s) are attached.

Date: _____

Signed: _____
Signature and Seal of Idaho Licensed Professional Engineer or Land Surveyor

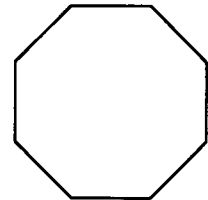

SECTION 4: COMPLETED BY LOCAL ADMINISTRATOR

ACTION

The proposed development is in conformance with applicable floodplain standards if: Joint Application for Stream Channel Alteration is approved by IDWR, USACE, IDL and/or (*) checked is "yes"↓.

(*) Necessary applications, information, certificates, and/or other permits are attached? Yes No

PERMIT IS APPROVED

The proposed development is NOT in conformance with applicable floodplain development standards.

PERMIT IS DENIED

Date: _____

Signed: _____
Signature of Local Administrator



FEMA

NATIONAL FLOOD INSURANCE PROGRAM

ELEVATION CERTIFICATE

AND

INSTRUCTIONS

NATIONAL FLOOD INSURANCE PROGRAM ELEVATION CERTIFICATE

PAPERWORK REDUCTION ACT NOTICE

Public reporting burden for this data collection is estimated to average 3.75 hours per response. The burden estimate includes the time for reviewing instructions, searching existing data sources, gathering and maintaining the data needed, and completing and submitting this form. You are not required to respond to this collection of information unless a valid OMB control number is displayed on this form. Send comments regarding the accuracy of the burden estimate and any suggestions for reducing the burden to: Information Collections Management, Department of Homeland Security, Federal Emergency Management Agency, 500 C Street SW, Washington DC 20472, Paperwork Reduction Project (1660-0008).

NOTE: Do not send your completed form to this address.

PURPOSE OF THE ELEVATION CERTIFICATE

The Elevation Certificate is an important administrative tool of the National Flood Insurance Program (NFIP). It is to be used to provide elevation information necessary to ensure compliance with community floodplain management ordinances, to determine the proper insurance premium rate, and to support a request for a Letter of Map Amendment (LOMA) or Letter of Map Revision based on fill (LOMR-F).

The Elevation Certificate is required in order to properly rate Post-FIRM buildings, which are buildings constructed after publication of the Flood Insurance Rate Map (FIRM), located in flood insurance Zones A1-A30, AE, AH, A (with BFE), VE, V1-V30, V (with BFE), AR, AR/A, AR/AE, AR/A1-A30, AR/AH, and AR/AO. The Elevation Certificate is not required for Pre-FIRM buildings unless the building is being rated under the optional Post-FIRM flood insurance rules.

As part of the agreement for making flood insurance available in a community, the NFIP requires the community to adopt floodplain management regulations that specify minimum requirements for reducing flood losses. One such requirement is for the community to obtain the elevation of the lowest floor (including basement) of all new and substantially improved buildings, and maintain a record of such information. The Elevation Certificate provides a way for a community to document compliance with the community's floodplain management ordinance.

Use of this certificate does not provide a waiver of the flood insurance purchase requirement. Only a LOMA or LOMR-F from the Federal Emergency Management Agency (FEMA) can amend the FIRM and remove the Federal mandate for a lending institution to require the purchase of flood insurance. However, the lending institution has the option of requiring flood insurance even if a LOMA/LOMR-F has been issued by FEMA. The Elevation Certificate may be used to support a LOMA or LOMR-F request. Lowest floor and lowest adjacent grade elevations certified by a surveyor or engineer will be required if the certificate is used to support a LOMA or LOMR-F request. A LOMA or LOMR-F request must be submitted with either a completed FEMA MT-EZ or MT-I package, whichever is appropriate.

This certificate is used only to certify building elevations. A separate certificate is required for floodproofing. Under the NFIP, non-residential buildings can be floodproofed up to or above the Base Flood Elevation (BFE). A floodproofed building is a building that has been designed and constructed to be watertight (substantially impermeable to floodwaters) below the BFE. Floodproofing of residential buildings is not permitted under the NFIP unless FEMA has granted the community an exception for residential floodproofed basements. The community must adopt standards for design and construction of floodproofed basements before FEMA will grant a basement exception. For both floodproofed non-residential buildings and residential floodproofed basements in communities that have been granted an exception by FEMA, a floodproofing certificate is required.

Additional guidance can be found in FEMA Publication 467-1, Floodplain Management Bulletin: Elevation Certificate, available on FEMA's website at <http://www.fema.gov/library/viewRecord.do?id=1727>.

ELEVATION CERTIFICATE

OMB No. 1660-0008
 Expires March 31, 2012

Important: Read the instructions on pages 1-9.

SECTION A - PROPERTY INFORMATION		For Insurance Company Use:
A1. Building Owner's Name		Policy Number
A2. Building Street Address (including Apt., Unit, Suite, and/or Bldg. No.) or P.O. Route and Box No.		Company NAIC Number
City	State	ZIP Code
A3. Property Description (Lot and Block Numbers, Tax Parcel Number, Legal Description, etc.)		
A4. Building Use (e.g., Residential, Non-Residential, Addition, Accessory, etc.)		
A5. Latitude/Longitude: Lat. _____ Long. _____		Horizontal Datum: <input type="checkbox"/> NAD 1927 <input type="checkbox"/> NAD 1983
A6. Attach at least 2 photographs of the building if the Certificate is being used to obtain flood insurance.		
A7. Building Diagram Number _____		
A8. For a building with a crawlspace or enclosure(s):		A9. For a building with an attached garage:
a) Square footage of crawlspace or enclosure(s) _____ sq ft		a) Square footage of attached garage _____ sq ft
b) No. of permanent flood openings in the crawlspace or enclosure(s) within 1.0 foot above adjacent grade _____		b) No. of permanent flood openings in the attached garage within 1.0 foot above adjacent grade _____
c) Total net area of flood openings in A8.b _____ sq in		c) Total net area of flood openings in A9.b _____ sq in
d) Engineered flood openings? <input type="checkbox"/> Yes <input type="checkbox"/> No		d) Engineered flood openings? <input type="checkbox"/> Yes <input type="checkbox"/> No

SECTION B - FLOOD INSURANCE RATE MAP (FIRM) INFORMATION					
B1. NFIP Community Name & Community Number		B2. County Name		B3. State	
B4. Map/Panel Number	B5. Suffix	B6. FIRM Index Date	B7. FIRM Panel Effective/Revised Date	B8. Flood Zone(s)	B9. Base Flood Elevation(s) (Zone AO, use base flood depth)
B10. Indicate the source of the Base Flood Elevation (BFE) data or base flood depth entered in Item B9. <input type="checkbox"/> FIS Profile <input type="checkbox"/> FIRM <input type="checkbox"/> Community Determined <input type="checkbox"/> Other (Describe) _____					
B11. Indicate elevation datum used for BFE in Item B9: <input type="checkbox"/> NGVD 1929 <input type="checkbox"/> NAVD 1988 <input type="checkbox"/> Other (Describe) _____					
B12. Is the building located in a Coastal Barrier Resources System (CBRS) area or Otherwise Protected Area (OPA)? <input type="checkbox"/> Yes <input type="checkbox"/> No Designation Date _____ <input type="checkbox"/> CBRS <input type="checkbox"/> OPA					

SECTION C - BUILDING ELEVATION INFORMATION (SURVEY REQUIRED)	
C1. Building elevations are based on: <input type="checkbox"/> Construction Drawings* <input type="checkbox"/> Building Under Construction* <input type="checkbox"/> Finished Construction *A new Elevation Certificate will be required when construction of the building is complete.	
C2. Elevations – Zones A1-A30, AE, AH, A (with BFE), VE, V1-V30, V (with BFE), AR, AR/A, AR/AE, AR/A1-A30, AR/AH, AR/AO. Complete Items C2.a-h below according to the building diagram specified in Item A7. Use the same datum as the BFE. Benchmark Utilized _____ Vertical Datum _____ Conversion/Comments _____	
Check the measurement used.	
a) Top of bottom floor (including basement, crawlspace, or enclosure floor) _____	<input type="checkbox"/> feet <input type="checkbox"/> meters (Puerto Rico only)
b) Top of the next higher floor _____	<input type="checkbox"/> feet <input type="checkbox"/> meters (Puerto Rico only)
c) Bottom of the lowest horizontal structural member (V Zones only) _____	<input type="checkbox"/> feet <input type="checkbox"/> meters (Puerto Rico only)
d) Attached garage (top of slab) _____	<input type="checkbox"/> feet <input type="checkbox"/> meters (Puerto Rico only)
e) Lowest elevation of machinery or equipment servicing the building (Describe type of equipment and location in Comments) _____	<input type="checkbox"/> feet <input type="checkbox"/> meters (Puerto Rico only)
f) Lowest adjacent (finished) grade next to building (LAG) _____	<input type="checkbox"/> feet <input type="checkbox"/> meters (Puerto Rico only)
g) Highest adjacent (finished) grade next to building (HAG) _____	<input type="checkbox"/> feet <input type="checkbox"/> meters (Puerto Rico only)
h) Lowest adjacent grade at lowest elevation of deck or stairs, including structural support _____	<input type="checkbox"/> feet <input type="checkbox"/> meters (Puerto Rico only)

SECTION D - SURVEYOR, ENGINEER, OR ARCHITECT CERTIFICATION			
This certification is to be signed and sealed by a land surveyor, engineer, or architect authorized by law to certify elevation information. I certify that the information on this Certificate represents my best efforts to interpret the data available. I understand that any false statement may be punishable by fine or imprisonment under 18 U.S. Code, Section 1001.			
<input type="checkbox"/> Check here if comments are provided on back of form.		Were latitude and longitude in Section A provided by a licensed land surveyor? <input type="checkbox"/> Yes <input type="checkbox"/> No	
Certifier's Name		License Number	
Title		Company Name	
Address		City	State ZIP Code
Signature		Date	Telephone

PLACE SEAL HERE

IMPORTANT: In these spaces, copy the corresponding information from Section A.			For Insurance Company Use:
Building Street Address (including Apt., Unit, Suite, and/or Bldg. No.) or P.O. Route and Box No.			Policy Number
City	State	ZIP Code	Company NAIC Number

SECTION D - SURVEYOR, ENGINEER, OR ARCHITECT CERTIFICATION (CONTINUED)

Copy both sides of this Elevation Certificate for (1) community official, (2) insurance agent/company, and (3) building owner.

Comments

Signature _____ Date _____ Check here if attachments

SECTION E - BUILDING ELEVATION INFORMATION (SURVEY NOT REQUIRED) FOR ZONE AO AND ZONE A (WITHOUT BFE)

For Zones AO and A (without BFE), complete Items E1-E5. If the Certificate is intended to support a LOMA or LOMR-F request, complete Sections A, B, and C. For Items E1-E4, use natural grade, if available. Check the measurement used. In Puerto Rico only, enter meters.

E1. Provide elevation information for the following and check the appropriate boxes to show whether the elevation is above or below the highest adjacent grade (HAG) and the lowest adjacent grade (LAG).

a) Top of bottom floor (including basement, crawlspace, or enclosure) is _____ feet meters above or below the HAG.

b) Top of bottom floor (including basement, crawlspace, or enclosure) is _____ feet meters above or below the LAG.

E2. For Building Diagrams 6-9 with permanent flood openings provided in Section A Items 8 and/or 9 (see pages 8-9 of Instructions), the next higher floor (elevation C2.b in the diagrams) of the building is _____ feet meters above or below the HAG.

E3. Attached garage (top of slab) is _____ feet meters above or below the HAG.

E4. Top of platform of machinery and/or equipment servicing the building is _____ feet meters above or below the HAG.

E5. Zone AO only: If no flood depth number is available, is the top of the bottom floor elevated in accordance with the community's floodplain management ordinance? Yes No Unknown. The local official must certify this information in Section G.

SECTION F - PROPERTY OWNER (OR OWNER'S REPRESENTATIVE) CERTIFICATION

The property owner or owner's authorized representative who completes Sections A, B, and E for Zone A (without a FEMA-issued or community-issued BFE) or Zone AO must sign here. *The statements in Sections A, B, and E are correct to the best of my knowledge.*

Property Owner's or Owner's Authorized Representative's Name _____

Address _____ City _____ State _____ ZIP Code _____

Signature _____ Date _____ Telephone _____

Comments

Check here if attachments

SECTION G - COMMUNITY INFORMATION (OPTIONAL)

The local official who is authorized by law or ordinance to administer the community's floodplain management ordinance can complete Sections A, B, C (or E), and G of this Elevation Certificate. Complete the applicable item(s) and sign below. Check the measurement used in Items G8 and G9.

- G1. The information in Section C was taken from other documentation that has been signed and sealed by a licensed surveyor, engineer, or architect who is authorized by law to certify elevation information. (Indicate the source and date of the elevation data in the Comments area below.)
- G2. A community official completed Section E for a building located in Zone A (without a FEMA-issued or community-issued BFE) or Zone AO.
- G3. The following information (Items G4-G9) is provided for community floodplain management purposes.

G4. Permit Number _____	G5. Date Permit Issued _____	G6. Date Certificate Of Compliance/Occupancy Issued _____
-------------------------	------------------------------	---

- G7. This permit has been issued for: New Construction Substantial Improvement
- G8. Elevation of as-built lowest floor (including basement) of the building _____ feet meters (PR) Datum _____
- G9. BFE or (in Zone AO) depth of flooding at the building site _____ feet meters (PR) Datum _____
- G10. Community's design flood elevation _____ feet meters (PR) Datum _____

Local Official's Name _____ Title _____

Community Name _____ Telephone _____

Signature _____ Date _____

Comments

Check here if attachments

Building Photographs

See Instructions for Item A6.

Building Street Address (including Apt., Unit, Suite, and/or Bldg. No.) or P.O. Route and Box No.			For Insurance Company Use:
			Policy Number
City	State	ZIP Code	Company NAIC Number

If using the Elevation Certificate to obtain NFIP flood insurance, affix at least two building photographs below according to the instructions for Item A6. Identify all photographs with: date taken; "Front View" and "Rear View"; and, if required, "Right Side View" and "Left Side View." If submitting more photographs than will fit on this page, use the Continuation Page on the reverse.

Building Photographs

Continuation Page

Building Street Address (including Apt., Unit, Suite, and/or Bldg. No.) or P.O. Route and Box No.			For Insurance Company Use:
			Policy Number
City	State	ZIP Code	Company NAIC Number

If submitting more photographs than will fit on the preceding page, affix the additional photographs below. Identify all photographs with: date taken; "Front View" and "Rear View"; and, if required, "Right Side View" and "Left Side View."

INSTRUCTIONS FOR COMPLETING THE ELEVATION CERTIFICATE

The Elevation Certificate is to be completed by a land surveyor, engineer, or architect who is authorized by law to certify elevation information when elevation information is required for Zones A1-A30, AE, AH, A (with BFE), VE, V1-V30, V (with BFE), AR, AR/A, AR/AE, AR/A1-A30, AR/AH, or AR/AO. Community officials who are authorized by law or ordinance to provide floodplain management information may also complete this form. For Zones AO and A (without BFE), a community official, a property owner, or an owner's representative may provide information on this certificate, unless the elevations are intended for use in supporting a request for a LOMA or LOMR-F. Certified elevations must be included if the purpose of completing the Elevation Certificate is to obtain a LOMA or LOMR-F.

The property owner, the owner's representative, or local official who is authorized by law to administer the community floodplain ordinance can complete Section A and Section B. The partially completed form can then be given to the land surveyor, engineer, or architect to complete Section C. The land surveyor, engineer, or architect should verify the information provided by the property owner or owner's representative to ensure that this certificate is complete.

In Puerto Rico only, elevations for building information and flood hazard information may be entered in meters.

SECTION A – PROPERTY INFORMATION

Items A1-A4. This section identifies the building, its location, and its owner. Enter the name(s) of the building owner(s), the building's complete street address, and the lot and block numbers. If the building's address is different from the owner's address, enter the address of the building being certified. If the address is a rural route or a Post Office box number, enter the lot and block numbers, the tax parcel number, the legal description, or an abbreviated location description based on distance and direction from a fixed point of reference. For the purposes of this certificate, "building" means both a building and a manufactured (mobile) home.

A map may be attached to this certificate to show the location of the building on the property. A tax map, FIRM, or detailed community map is appropriate. If no map is available, provide a sketch of the property location, and the location of the building on the property. Include appropriate landmarks such as nearby roads, intersections, and bodies of water. For building use, indicate whether the building is residential, non-residential, an addition to an existing residential or non-residential building, an accessory building (e.g., garage), or other type of structure. Use the Comments area of the appropriate section if needed, or attach additional comments.

Item A5. Provide latitude and longitude coordinates for the center of the front of the building. Use either decimal degrees (e.g., 39.5043°, -110.7585°) or degrees, minutes, seconds (e.g., 39° 30' 15.5", -110° 45' 30.7") format. If decimal degrees are used, provide coordinates to at least 4 decimal places or better. When using degrees, minutes, seconds, provide seconds to at least 1 decimal place or better. The latitude and longitude coordinates must be accurate within 66 feet. When the latitude and longitude are provided by a surveyor, check the "Yes" box in Section D and indicate the method used to determine the latitude and longitude in the Comments area of Section D. If the Elevation Certificate is being certified by other than a licensed surveyor, engineer, or architect, this information is not required. Provide the type of datum used to obtain the latitude and longitude. FEMA prefers the use of NAD 1983.

Item A6. If the Elevation Certificate is being used to obtain flood insurance through the NFIP, the certifier must provide at least two photographs showing the front and rear of the building taken within 90 days from the date of certification. The photographs must be taken with views confirming the building description and diagram number provided in Section A. To the extent possible, these photographs should show the entire building including foundation. If the building has split-level or multi-level areas, provide at least two additional photographs showing side views of the building. In addition, when applicable, provide a photograph of the foundation showing a representative example of the flood openings or vents. All photographs must be in color and measure at least 3"x3". Digital photographs are acceptable.

Item A7. Select the diagram on pages 7-9 that best represents the building. Then enter the diagram number and use the diagram to identify and determine the appropriate elevations requested in Items C2.a-h. If you are unsure of the correct diagram, select the diagram that most closely resembles the building being certified.

Item A8.a Provide the square footage of the crawlspace or enclosure(s) below the lowest elevated floor of an elevated building with or without permanent flood openings. Take the measurement from the outside of the crawlspace or enclosure(s). Examples of elevated buildings constructed with crawlspace and enclosure(s) are shown in Diagrams 6-9 on pages 8-9. Diagram 2, 4, or 9 should be used for a building constructed with a crawlspace floor that is below the exterior grade on all sides.

Items A8.b-d Enter in Item A8.b the number of permanent flood openings in the crawlspace or enclosure(s) that are no higher than 1.0 foot above the higher of the exterior or interior grade or floor immediately below the opening. (A permanent flood opening is a flood vent or other opening that allows the free passage of water automatically in both directions without human intervention.) If the interior grade elevation is used, note this in the Comments area of Section D. Estimate the total net area of all such permanent flood openings in square inches, excluding any bars, louvers, or other covers of the permanent flood openings, and enter the total in Item A8.c. If the net area cannot be reasonably estimated, provide the size of the flood openings without consideration of any covers and indicate in the Comments area the type of cover that exists in the flood openings. Indicate in Item A8.d whether the flood openings are engineered. If applicable, attach a copy of the Individual Engineered Flood Openings Certification or an Evaluation Report issued by the International Code Council Evaluation Service (ICC ES), if you have it. If the crawlspace or enclosure(s) have no permanent flood openings, or if the openings are not within 1.0 foot above adjacent grade, enter “0” (zero) in Items A8.b-c.

Item A9.a Provide the square footage of the attached garage with or without permanent flood openings. Take the measurement from the outside of the garage.

Items A9.b-d Enter in Item A9.b the number of permanent flood openings in the attached garage that are no higher than 1.0 foot above the higher of the exterior or interior grade or floor immediately below the opening. (A permanent flood opening is a flood vent or other opening that allows the free passage of water automatically in both directions without human intervention.) If the interior grade elevation is used, note this in the Comments area of Section D. This includes any openings that are in the garage door that are no higher than 1.0 foot above the adjacent grade. Estimate the total net area of all such permanent flood openings in square inches and enter the total in Item A9.c. If the net area cannot be reasonably estimated, provide the size of the flood openings without consideration of any covers and indicate in the Comments area the type of cover that exists in the flood openings. Indicate in Item A9.d whether the flood openings are engineered. If applicable, attach a copy of the Individual Engineered Flood Openings Certification or an Evaluation Report issued by the International Code Council Evaluation Service (ICC ES), if you have it. If the garage has no permanent flood openings, or if the openings are not within 1.0 foot above adjacent grade, enter “0” (zero) in Items A9.b-c.

SECTION B - FLOOD INSURANCE RATE MAP (FIRM) INFORMATION

Complete the Elevation Certificate on the basis of the FIRM in effect at the time of the certification.

The information for Section B is obtained by reviewing the FIRM panel that includes the building’s location. Information about the current FIRM is available from the Federal Emergency Management Agency (FEMA) by calling 1-800-358-9616. If a Letter of Map Amendment (LOMA) or Letter of Map Revision (LOMR-F) has been issued by FEMA, please provide the letter date and case number in the Comments area of Section D or Section G, as appropriate.

For a building in an area that has been annexed by one community but is shown on another community’s FIRM, enter the community name and 6-digit number of the annexing community in Item B1, the name of the county or new county, if necessary, in Item B2, and the FIRM index date for the annexing community in Item B6. Enter information from the actual FIRM panel that shows the building location, even if it is the FIRM for the previous jurisdiction, in Items B4, B5, B7, B8, and B9.

If the map in effect at the time of the building’s construction was other than the current FIRM, and you have the past map information pertaining to the building, provide the information in the Comments area of Section D.

Item B1. NFIP Community Name & Community Number. Enter the complete name of the community in which the building is located and the associated 6-digit community number. For a newly incorporated community, use the name and 6-digit number of the new community. Under the NFIP, a “community” is any State or area or political subdivision thereof, or any Indian tribe or authorized native organization, that has authority to adopt and enforce floodplain management regulations for the areas within its jurisdiction. To determine the current community number, see the NFIP *Community Status Book*, available on FEMA’s web site at <http://www.fema.gov/fema/csb.shtm>, or call 1-800-358-9616.

Item B2. County Name. Enter the name of the county or counties in which the community is located. For an unincorporated area of a county, enter “unincorporated area.” For an independent city, enter “independent city.”

Item B3. State. Enter the 2-letter state abbreviation (for example, VA, TX, CA).

Items B4-B5. Map/Panel Number and Suffix. Enter the 10-character “Map Number” or “Community Panel Number” shown on the FIRM where the building or manufactured (mobile) home is located. For maps in a county-wide format, the sixth character of the “Map Number” is the letter “C” followed by a four-digit map number. For maps not in a county-wide format, enter the “Community Panel Number” shown on the FIRM.

Item B6. FIRM Index Date. Enter the effective date or the map revised date shown on the FIRM Index.

Item B7. FIRM Panel Effective/Revised Date. Enter the map effective date or the map revised date shown on the FIRM panel. This will be the latest of all dates shown on the map. The current FIRM panel effective date can be determined by calling 1-800-358-9616.

Item B8. Flood Zone(s). Enter the flood zone, or flood zones, in which the building is located. All flood zones containing the letter “A” or “V” are considered Special Flood Hazard Areas. The flood zones are A, AE, A1-A30, V, VE, V1-V30, AH, AO, AR, AR/A, AR/AE, AR/A1-A30, AR/AH, and AR/AO. Each flood zone is defined in the legend of the FIRM panel on which it appears.

Item B9. Base Flood Elevation(s). Using the appropriate Flood Insurance Study (FIS) Profile, Floodway Data Table, or FIRM panel, locate the property and enter the BFE (or base flood depth) of the building site. If the building is located in more than one flood zone in Item B8, list all appropriate BFEs in Item B9. BFEs are shown on a FIRM or FIS Profile for Zones A1-A30, AE, AH, V1-V30, VE, AR, AR/A, AR/AE, AR/A1-A30, AR/AH, and AR/AO; flood depth numbers are shown for Zone AO. Use the AR BFE if the building is located in any of Zones AR/A, AR/AE, AR/A1-A30, AR/AH, or AR/AO. In A or V zones where BFEs are not provided on the FIRM, BFEs may be available from another source. For example, the community may have established BFEs or obtained BFE data from other sources for the building site. For subdivisions and other developments of more than 50 lots or 5 acres, establishment of BFEs is required by the community’s floodplain management ordinance. If a BFE is obtained from another source, enter the BFE in Item B9. In an A Zone where BFEs are not available, complete Section E and enter N/A for Section B, Item B9. Enter the BFE to the nearest tenth of a foot (nearest tenth of a meter, in Puerto Rico).

Item B10. Indicate the source of the BFE that you entered in Item B9. If the BFE is from a source other than FIS Profile, FIRM, or community, describe the source of the BFE.

Item B11. Indicate the elevation datum to which the elevations on the applicable FIRM are referenced as shown on the map legend. The vertical datum is shown in the Map Legend and/or the Notes to Users on the FIRM.

Item B12. Indicate whether the building is located in a Coastal Barrier Resources System (CBRS) area or Otherwise Protected Area (OPA). (OPAs are portions of coastal barriers that are owned by Federal, State, or local governments or by certain non-profit organizations and used primarily for natural resources protection.) Federal flood insurance is prohibited in designated CBRS areas or OPAs for buildings or manufactured (mobile) homes built or substantially improved after the date of the CBRS or OPA designation. For the first CBRS designations, that date is October 1, 1983. Information about CBRS areas and OPAs may be obtained on the FEMA web site at <http://www.fema.gov/business/nfip/cbrs/cbrs.shtm>.

SECTION C - BUILDING ELEVATION INFORMATION (SURVEY REQUIRED)

Complete Section C if the building is located in any of Zones A1-A30, AE, AH, A (with BFE), VE, V1-V30, V (with BFE), AR, AR/A, AR/AE, AR/A1-A30, AR/AH, or AR/AO, or if this certificate is being used to support a request for a LOMA or LOMR-F. If the building is located in Zone AO or Zone A (without BFE), complete Section E instead. To ensure that all required elevations are obtained, it may be necessary to enter the building (for instance, if the building has a basement or sunken living room, split-level construction, or machinery and equipment).

Surveyors may not be able to gain access to some crawlspaces to shoot the elevation of the crawlspace floor. If access to the crawlspace is limited or cannot be gained, follow one of these procedures.

- Use a yardstick or tape measure to measure the height from the floor of the crawlspace to the “next higher floor,” and then subtract the crawlspace height from the elevation of the “next higher floor.” If there is no access to the crawlspace, use the exterior grade next to the structure to measure the height of the crawlspace to the “next higher floor.”
- Contact the local floodplain administrator of the community in which the building is located. The community may have documentation of the elevation of the crawlspace floor as part of the permit issued for the building.
- If the property owner has documentation or knows the height of the crawlspace floor to the next higher floor, try to verify this by looking inside the crawlspace through any openings or vents.

In all three cases, provide the elevation in the Comments area of Section D on the back of the form and a brief description of how the elevation was obtained.

Item C1. Indicate whether the elevations to be entered in this section are based on construction drawings, a building under construction, or finished construction. For either of the first two choices, a post-construction Elevation Certificate will be

required when construction is complete. If the building is under construction, include only those elevations that can be surveyed in Items C2.a-h. Use the Comments area of Section D to provide elevations obtained from the construction plans or drawings. Select "Finished Construction" only when all machinery and/or equipment such as furnaces, hot water heaters, heat pumps, air conditioners, and elevators and their associated equipment have been installed and the grading around the building is completed.

Item C2. A field survey is required for Items C2.a-h. Most control networks will assign a unique identifier for each benchmark. For example, the National Geodetic Survey uses the Permanent Identifier (PID). For the benchmark utilized, provide the PID or other unique identifier assigned by the maintainer of the benchmark. For GPS survey, indicate the benchmark used for the base station, the Continuously Operating Reference Stations (CORS) sites used for an On-line Positioning User Service (OPUS) solution (also attach the OPUS report), or the name of the Real Time Network used.

Also provide the vertical datum for the benchmark elevation. All elevations for the certificate, including the elevations for Items C2.a-h, must use the same datum on which the BFE is based. Show the conversion from the field survey datum used if it differs from the datum used for the BFE entered in Item B9 and indicate the conversion software used. Show the datum conversion, if applicable, in this section or in the Comments area of Section D.

For property experiencing ground subsidence, the most recent reference mark elevations must be used for determining building elevations. However, when subsidence is involved, the BFE should not be adjusted. Enter elevations in Items C2.a-h to the nearest tenth of a foot (nearest tenth of a meter, in Puerto Rico).

Items C2.a-d Enter the building elevations (excluding the attached garage) indicated by the selected building diagram (Item A7) in Items C2.a-c. If there is an attached garage, enter the elevation for top of attached garage slab in Item C2.d. (Because elevation for top of attached garage slab is self-explanatory, attached garages are not illustrated in the diagrams.) If the building is located in a V zone on the FIRM, complete Item C2.c. If the flood zone cannot be determined, enter elevations for all of Items C2.a-h. For buildings in A zones, elevations a, b, d, and e should be measured at the top of the floor. For buildings in V zones, elevation c must be measured at the bottom of the lowest horizontal structural member of the floor (see drawing below). For buildings elevated on a crawlspace, Diagrams 8 and 9, enter the elevation of the top of the crawlspace floor in Item C2.a, whether or not the crawlspace has permanent flood openings (flood vents). *If any item does not apply to the building, enter "N/A" for not applicable.*

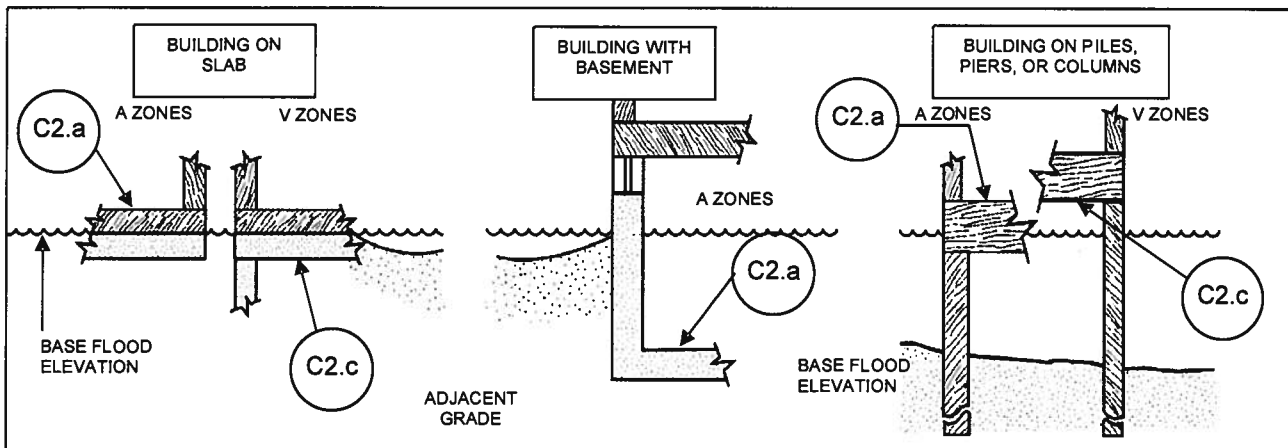

Item C2.e Enter the lowest platform elevation of at least one of the following machinery and equipment items: elevators and their associated equipment, furnaces, hot water heaters, heat pumps, and air conditioners in an attached garage or enclosure or on an open utility platform that provides utility services for the building. Note that elevations for these specific machinery and equipment items are required in order to rate the building for flood insurance. Local floodplain management officials are required to ensure that all machinery and equipment servicing the building are protected from flooding. Thus, local officials may require that elevation information for all machinery and equipment, including ductwork, be documented on the Elevation Certificate. If the machinery and/or equipment is mounted to a wall, pile, etc., enter the platform elevation of the machinery and/or equipment. Indicate machinery/equipment type and its general location, e.g., on floor inside garage or on platform affixed to exterior wall, in the Comments area of Section D or Section G, as appropriate. *If this item does not apply to the building, enter "N/A" for not applicable.*

Items C2.f-g Enter the elevation of the ground, sidewalk, or patio slab immediately next to the building. For Zone AO, use the natural grade elevation, if available. This measurement must be to the nearest tenth of a foot (nearest tenth of a meter, in Puerto Rico) if this certificate is being used to support a request for a LOMA or LOMR-F.

Item C2.h Enter the lowest grade elevation at the deck support or stairs. For Zone AO, use the natural grade elevation, if available. This measurement must be to the nearest tenth of a foot (nearest tenth of a meter, in Puerto Rico) if this certificate is being used to support a request for a LOMA or LOMR-F.

SECTION D - SURVEYOR, ENGINEER, OR ARCHITECT CERTIFICATION

Complete as indicated. This section of the Elevation Certificate may be signed by only a land surveyor, engineer, or architect who is authorized by law to certify elevation information. Place your license number, your seal (as allowed by the State licensing board), your signature, and the date in the box in Section D. You are certifying that the information on this certificate represents your best efforts to interpret the data available and that you understand that any false statement may be punishable by fine or imprisonment under 18 U.S. Code, Section 1001. Use the Comments area of Section D, on the back of the certificate, to provide datum, elevation, openings, or other relevant information not specified on the front.

SECTION E - BUILDING ELEVATION INFORMATION (SURVEY NOT REQUIRED) FOR ZONE AO & ZONE A (WITHOUT BFE)

Complete Section E if the building is located in Zone AO or Zone A (without BFE). Otherwise, complete Section C instead. Explain in the Section F Comments area if the measurement provided under Items E1- E4 is based on the “natural grade.”

Items E1.a and b Enter in Item E1.a the height to the nearest tenth of a foot (tenth of a meter in Puerto Rico) of the top of the bottom floor (as indicated in the applicable diagram) above or below the highest adjacent grade (HAG). Enter in Item E1.b the height to the nearest tenth of a foot (tenth of a meter in Puerto Rico) of the top of the bottom floor (as indicated in the applicable diagram) above or below the lowest adjacent grade (LAG). For buildings in Zone AO, the community’s floodplain management ordinance requires the lowest floor of the building be elevated above the highest adjacent grade at least as high as the depth number on the FIRM. Buildings in Zone A (without BFE) may qualify for a lower insurance rate if an engineered BFE is developed at the site.

Item E2. For Building Diagrams 6-9 with permanent flood openings (see pages 8-9), enter the height to the nearest tenth of a foot (tenth of a meter in Puerto Rico) of the next higher floor or elevated floor (as indicated in the applicable diagram) above or below the highest adjacent grade (HAG).

Item E3. Enter the height to the nearest tenth of a foot (tenth of a meter in Puerto Rico), in relation to the highest adjacent grade next to the building, for the top of attached garage slab. (Because elevation for top of attached garage slab is self-explanatory, attached garages are not illustrated in the diagrams.) *If this item does not apply to the building, enter “N/A” for not applicable.*

Item E4. Enter the height to the nearest tenth of a foot (tenth of a meter in Puerto Rico), in relation to the highest adjacent grade next to the building, of the platform elevation that supports the machinery and/or equipment servicing the building. Indicate machinery/equipment type in the Comments area of Section F. *If this item does not apply to the building, enter “N/A” for not applicable.*

Item E5. For those communities where this base flood depth is not available, the community will need to determine whether the top of the bottom floor is elevated in accordance with the community’s floodplain management ordinance.

SECTION F - PROPERTY OWNER (OR OWNER’S REPRESENTATIVE) CERTIFICATION

Complete as indicated. This section is provided for certification of measurements taken by a property owner or property owner’s representative when responding to Sections A, B, and E. The address entered in this section must be the actual mailing address of the property owner or property owner’s representative who provided the information on the certificate.

SECTION G - COMMUNITY INFORMATION (OPTIONAL)

Complete as indicated. The community official who is authorized by law or ordinance to administer the community’s floodplain management ordinance can complete Sections A, B, C (or E), and G of this Elevation Certificate. Section C may be

filled in by the local official as provided in the instructions below for Item G1. If the authorized community official completes Sections C, E, or G, complete the appropriate item(s) and sign this section.

Check **Item G1** if Section C is completed with elevation data from other documentation, including elevations obtained from the Community Rating System Elevation Software, that has been signed and sealed by a licensed surveyor, engineer, or architect who is authorized by law to certify elevation information. Indicate the source of the elevation data and the date obtained in the Comments area of Section G. If you are both a community official and a licensed land surveyor, engineer, or architect authorized by law to certify elevation information, and you performed the actual survey for a building in Zones A1-A30, AE, AH, A (with BFE), VE, V1-V30, V (with BFE), AR, AR/A, AR/A1-A30, AR/AE, AR/AH, or AR/AO, you must also complete Section D.

Check **Item G2** if information is entered in Section E by the community for a building in Zone A (without a FEMA-issued or community-issued BFE) or Zone AO.

Check **Item G3** if the information in Items G4-G10 has been completed for community floodplain management purposes to document the as-built lowest floor elevation of the building. Section C of the Elevation Certificate records the elevation of various building components but does not determine the lowest floor of the building or whether the building, as constructed, complies with the community's floodplain management ordinance. This must be done by the community. Items G4-G10 provide a way to document these determinations.

Item G4. Permit Number. Enter the permit number or other identifier to key the Elevation Certificate to the permit issued for the building.

Item G5. Date Permit Issued. Enter the date the permit was issued for the building.

Item G6. Date Certificate of Compliance/Occupancy Issued. Enter the date that the Certificate of Compliance or Occupancy or similar written official documentation of as-built lowest floor elevation was issued by the community as evidence that all work authorized by the floodplain development permit has been completed in accordance with the community's floodplain management laws or ordinances.

Item G7. New Construction or Substantial Improvement. Check the applicable box. "Substantial Improvement" means any reconstruction, rehabilitation, addition, or other improvement of a building, the cost of which equals or exceeds 50 percent of the market value of the building before the start of construction of the improvement. The term includes buildings that have incurred substantial damage, regardless of the actual repair work performed.

Item G8. As-built lowest floor elevation. Enter the elevation of the lowest floor (including basement) when the construction of the building is completed and a final inspection has been made to confirm that the building is built in accordance with the permit, the approved plans, and the community's floodplain management laws or ordinances. Indicate the elevation datum used.

Item G9. BFE. Using the appropriate FIRM panel, FIS Profile, or other data source, locate the property and enter the BFE (or base flood depth) of the building site. Indicate the elevation datum used.

Item G10. Community's design flood elevation. Enter the elevation (including freeboard above the BFE) to which the community requires the lowest floor to be elevated. Indicate the elevation datum used.

Enter your name, title, and telephone number, and the name of the community. Sign and enter the date in the appropriate blanks.

BUILDING DIAGRAMS

The following diagrams illustrate various types of buildings. Compare the features of the building being certified with the features shown in the diagrams and select the diagram most applicable. Enter the diagram number in Item A7, the square footage of crawlspace or enclosure(s) and the area of flood openings in square inches in Items A8.a-c, the square footage of attached garage and the area of flood openings in square inches in Items A9.a-c, and the elevations in Items C2.a-h.

In A zones, the floor elevation is taken at the top finished surface of the floor indicated; in V zones, the floor elevation is taken at the bottom of the lowest horizontal structural member (see drawing in instructions for Section C).

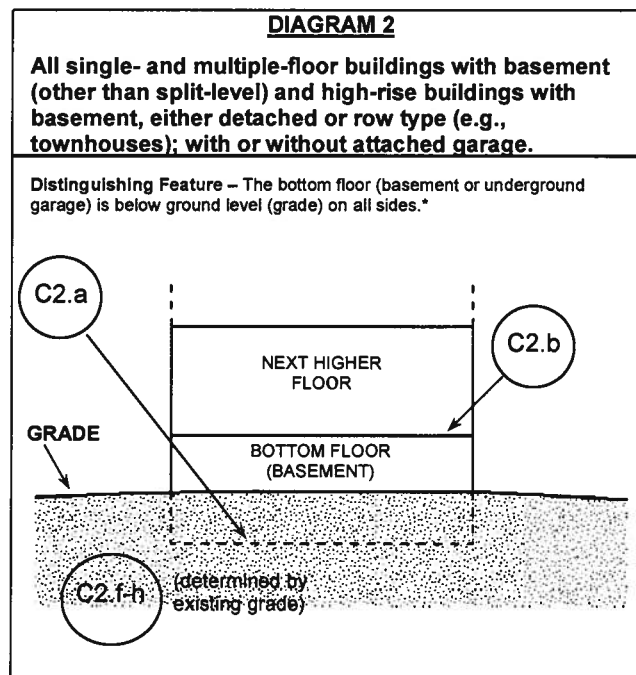
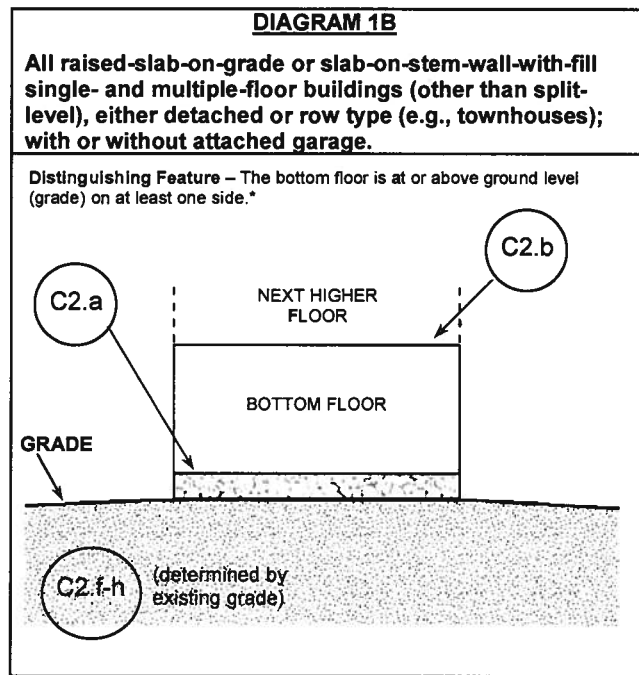
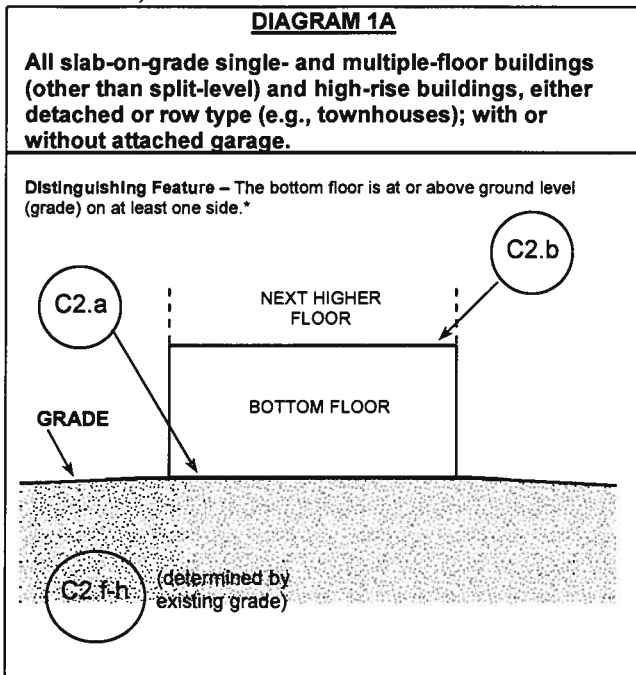

* A floor that is below ground level (grade) on all sides is considered a basement even if the floor is used for living purposes, or as an office, garage, workshop, etc

DIAGRAM 3

All split-level buildings that are slab-on-grade, either detached or row type (e.g., townhouses); with or without attached garage.

Distinguishing Feature – The bottom floor (excluding garage) is at or above ground level (grade) on at least one side.*

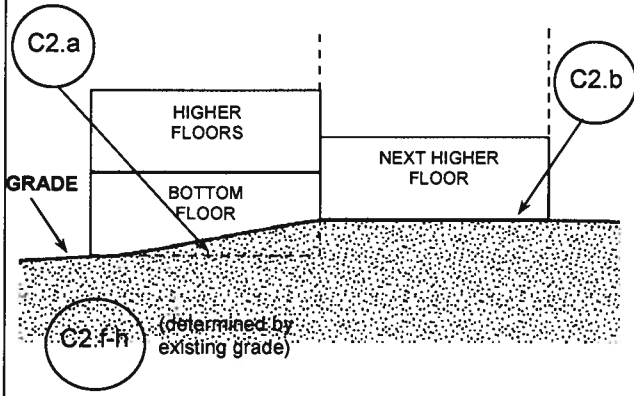

DIAGRAM 4

All split-level buildings (other than slab-on-grade), either detached or row type (e.g., townhouses); with or without attached garage.

Distinguishing Feature – The bottom floor (basement or underground garage) is below ground level (grade) on all sides.*

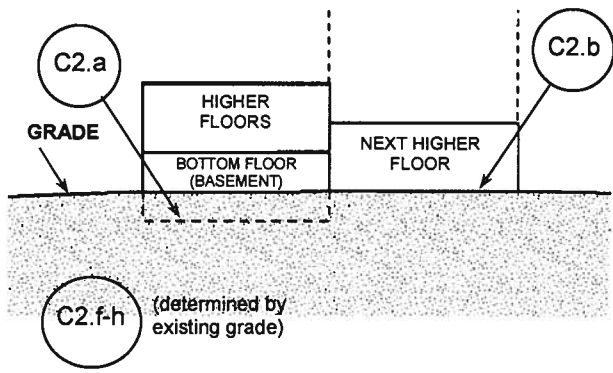

DIAGRAM 5

All buildings elevated on piers, posts, piles, columns, or parallel shear walls. No obstructions below the elevated floor.

Distinguishing Feature – For all zones, the area below the elevated floor is open, with no obstruction to flow of flood waters (open lattice work and/or insect screening is permissible).

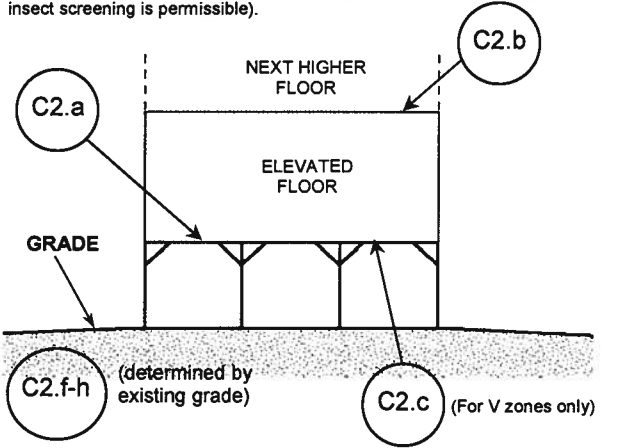
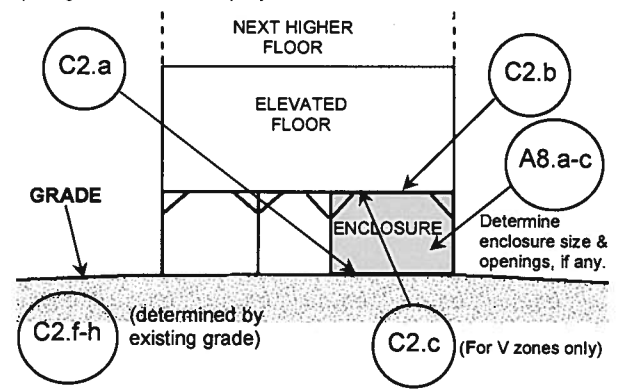

DIAGRAM 6

All buildings elevated on piers, posts, piles, columns, or parallel shear walls with full or partial enclosure below the elevated floor.

Distinguishing Feature – For all zones, the area below the elevated floor is enclosed, either partially or fully. In A Zones, the partially or fully enclosed area below the elevated floor is with or without openings** present in the walls of the enclosure. Indicate information about enclosure size and openings in Section A – Property Information.



* A floor that is below ground level (grade) on all sides is considered a basement even if the floor is used for living purposes, or as an office, garage, workshop, etc.

** An "opening" is a permanent opening that allows for the free passage of water automatically in both directions without human intervention. Under the NFIP, a minimum of two openings is required for enclosures or crawlspaces. The openings shall provide a total net area of not less than one square inch for every square foot of area enclosed, excluding any bars, louvers, or other covers of the opening. Alternatively, an Individual Engineered Flood Openings Certification or an Evaluation Report issued by the International Code Council Evaluation Service (ICC ES) must be submitted to document that the design of the openings will allow for the automatic equalization of hydrostatic flood forces on exterior walls. A window, a door, or a garage door is not considered an opening; openings may be installed in doors. Openings shall be on at least two sides of the enclosed area. If a building has more than one enclosed area, each area must have openings to allow floodwater to directly enter. The bottom of the openings must be no higher than one foot above the higher of the exterior or interior grade or floor immediately below the opening. For more guidance on openings, see NFIP Technical Bulletin 1.

DIAGRAM 7

All buildings elevated on full-story foundation walls with a partially or fully enclosed area below the elevated floor. This includes walkout levels, where at least one side is at or above grade. The principal use of this building is located in the elevated floors of the building.

Distinguishing Feature – For all zones, the area below the elevated floor is enclosed, either partially or fully. In A Zones, the partially or fully enclosed area below the elevated floor is with or without openings* present in the walls of the enclosure. Indicate information about enclosure size and openings in Section A – Property Information.

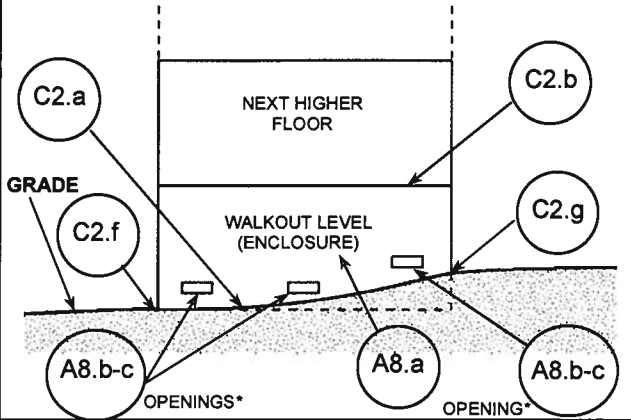

DIAGRAM 8

All buildings elevated on a crawlspace with the floor of the crawlspace at or above grade on at least one side, with or without an attached garage.

Distinguishing Feature – For all zones, the area below the first floor is enclosed by solid or partial perimeter walls. In all A zones, the crawlspace is with or without openings* present in the walls of the crawlspace. Indicate information about crawlspace size and openings in Section A – Property Information.

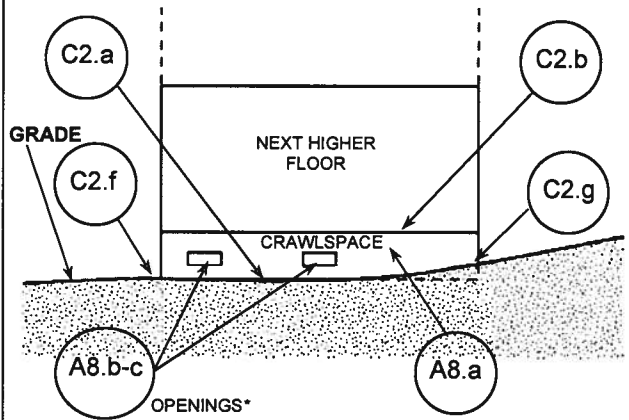
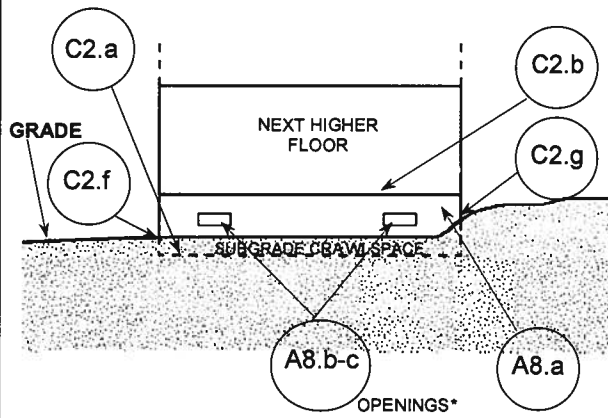

DIAGRAM 9

All buildings (other than split-level) elevated on a sub-grade crawlspace, with or without attached garage.

Distinguishing Feature – The bottom (crawlspace) floor is at or below ground level (grade) on all sides.** (If the distance from the crawlspace floor to the top of the next higher floor is more than 5 feet, or the crawlspace floor is more than 2 feet below the grade (LAG) on all sides, use Diagram 2.)



* An "opening" is a permanent opening that allows for the free passage of water automatically in both directions without human intervention. Under the NFIP, a minimum of two openings is required for enclosures or crawlspaces. The openings shall provide a total net area of not less than one square inch for every square foot of area enclosed, excluding any bars, louvers, or other covers of the opening. Alternatively, an Individual Engineered Flood Openings Certification or an Evaluation Report issued by the International Code Council Evaluation Service (ICC ES) must be submitted to document that the design of the openings will allow for the automatic equalization of hydrostatic flood forces on exterior walls. A window, a door, or a garage door is not considered an opening; openings may be installed in doors. Openings shall be on at least two sides of the enclosed area. If a building has more than one enclosed area, each area must have openings to allow floodwater to directly enter. The bottom of the openings must be no higher than one foot above the higher of the exterior or interior grade or floor immediately below the opening. For more guidance on openings, see NFIP Technical Bulletin 1.

** A floor that is below ground level (grade) on all sides is considered a basement even if the floor is used for living purposes, or as an office, garage, workshop, etc.

